



MARKET EKİPMANLARI
MARKET EQUIPMENT

İÇİNDEKİLER INDEX

YARIM ASIRLIK GÜÇLÜ KURULUŞ, SÜREKLİ KALİTELİ YATIRIM HALF A CENTURY OF STRONG INSTITUTIONS, QUALITY INVESTMENTS

1968 yılı sektöre, çelik civatalı depo rafları satışıyla girilmiştir.

1978 yılında sattığımız bu ürünlerin imalatına başlanmıştır.

1990 başından itibaren de Organize Sanayi Bölgesi'ndeki yeni üretim alanına geçilmiş ve Market-Mağaza Raf Sistemleri segmenti ürün çeşitliliğimize katılmıştır.

2006 yılında başlayan birinci yatırım planlarımız çerçevesinde yapılan yatırımlar sonucu Galvaniz ve Nikelaj Kaplama, Elektrostatik Toz Boya Kaplama Tesisi, Metal ve Ahşap Market - Mağaza Raf Sistemleri üretim hatlarıyla, ek makinelerle, en son teknolojiyi kullanarak faaliyetini sürdürmektedir.

2012 yılında Organize Sanayi Bölgesinde yatırımını tamamladığımız ikinci üretim tesisimiz faaliyete geçirilmiştir.

2013 yılında Depo Raf Sistemleri ileri teknolojiye sahip rollforming üretim ve robot kaynak hatları ile otomatik elektrostatik toz boya kaplama hatları devreye alınmıştır.

Halihazırda Kayseri 1. Organize Sanayi Bölgesindeki iki ayrı üretim tesisinde:

- Depo Raf Sistemleri
- Market Raf Sistemleri
- Mağaza Raf Sistemleri
- Market ve Lojistik Arabalar
- Konteyner ve Sepetler
- Yazar Kasa Altlıkları üretimi yapılmaktadır.

Merkez Müdürlükler, Ankara Bölge Müdürlüğü, Kayseri Şube Müdürlüğü ve bağlı yurtiçi ve yurtdışı bayilikler kanalı ile pazarlama - satış ve montaj hizmetleri verilmektedir.

Somçelik, (Balkan Ülkeleri, Arap Ülkeleri, Ortadoğu Ülkeleri, Uzakdoğu Ülkeleri, Türk Cumhuriyetleri, Rusya ve Avrupa Ülkeleri'nden) bir çok farklı kıtaya ülkeye ihracat yapmaktadır.

İmalat ve hizmet alanlarında dünyadaki bilgi ve çeşitliliği tüketiciyle buluşturmak,

- Tüketicinin beklentilerini ve gereksinimlerini karşılayacak kaliteli ürün ve hizmetlerin sunumunu yapmak,

- Kaynaklarını etkin kullanarak, çevreye duyarlı, rekabet edebilir kalitede, en az maliyetle, en fazla ve satılabilir üretim yapmak,

- Yenilik ve gelişmelere açık iş paydaşlarının beklentilerini karşılayan, ülke ekonomisine katkıda bulunan bir dünya şirketi olmak,

- Çalışanlarının kişisel bilgisi, tecrübesinin yanına teknoloji ve takım ruhunu katarak kaliteli imalat ve hizmeti gerçekleştirmek,

- Müşterilerinin değişen ihtiyaçlarının farkında olarak, esnek yapısıyla, öncü ve yaratıcı çözümleriyle, müşterilerinin yaşamlarına değer katan, onları farklı kılan ürün ve hizmetler tasarlayıp sunmak,

- Yurt içinde ve yurt dışında gelişen perakende sektöründe market ve mağazalar zincirinin teşhir ve raf sistemleri ihtiyacını, modern bir anlayışla, tüketici ihtiyaç ve isteklerini azami ölçüde karşılayacak bir estetik yaklaşımla ve konusunda uzman ve tecrübeli bir teknik kadroyla karşılamak temel Misyonudur.

İçinde bulunduğu ve hep var olmayı amaçladığı bu sektörde: Teknolojik gelişmeleri takip ederek, tecrübeli ve uzman kadrosu ile gerek iç piyasada ve gerekse yurt dışında lider marka olmak, Birlikte çalıştığı kişi, kurum ve kuruluşlar ile çalışanları açısından oluşturduğu güvenilirliği sürdürmek ve her zaman tercih edilen, müşteri odaklı çalışan iş paydaşı olmak temel Vizyonudur.

- 2020 Yılında plastik market arabası ve plastik el sepeti ürünlerini de kendi bünyesine katmıştır. Tam otomatik kaplama tesisi ile kalitesini daha da arttırmayı hedeflemiştir.

- 2023 yılında yeni yatırımlarına devam etmektedir.

In 1968 we start to sell bolted steel warehouse shelves.

In 1978 we start to produce the items we are selling.

From the beginning of 1990 it has been passed to a new production area in the Organized Industrial Zone and Market-Store Shelving Systems segment is added to our product assortment.

As a result of our first investment plan starting in 2006, continues to operate using the latest technology, with the investments of Galvanized and nickel plating, electrostatic powder coating plant, metal and wood market - store shelving system production lines and with additional machines.

In 2012, we completed our second production plant investment, in the Organized Industrial Zone has been activated.

2013 Warehouse Shelving Systems rollforming and robot welding production lines with advanced technology with automatic electrostatic powder coating line has been commissioned.

Currently, two separate manufacturing facilities in Kayseri 1. Organized Industrial Zone:

- Warehouse Shelving Systems
- Supermarket Shelves Systems
- Store Shelving Systems
- Shopping and Logistics Trolleys
- Baskets and Containers
- Checkout Desks productions are carried out.

Marketing, sales and installation services are being served by Head Quarter, Ankara, Kayseri Branch Directorate and with its domestic and international sales agents.

Somçelik is exporting to many different continents and countries (Balkan Countries, Arab Countries, Middle East Countries, Asian Countries, Turkish Republics, Russia and the European Countries).

To bring together with customer and knowledge and diversity of the world in Manufacturing and Service areas,

The presentation of quality products and services to meet the requirements and Consumer expectations Effective use of resources, environmentally sensitive, competitive quality,

Least cost, to produce the most and can be sold, Open to innovations and developments,

Meeting the expectations of business stakeholders, being a global company that contributes to the national economy,

To perform high quality manufacturing and services by adding Employees' personal knowledge, experience, technology and team spirit.

Aware of the changing needs of its customers, flexible structure, pioneering and innovative solutions, adding value to the lives of its customers, to design and deliver products and services that make them different,

In the developing of Retail sector in the country and abroad, supermarkets and department stores needs of display and shelf systems, a modern mentality, to the maximum extent to meet consumer needs and desires of an aesthetic approach and a technical expert and experienced staff to meet are our basic Missions.

And in the sector we are in and have always intended to be located in this sector: being a leading brand in domestic market and abroad by following the technological developments, with experienced and expert staff, Working with individuals, institutions and organizations created for the employees to maintain the reliability and always preferred to be customer-oriented business stakeholders' are our basic Vision.

In 2020 we start to produce plastic shopping trolleys a shopping basket production. Somçelik alimed to increase the quality with full automatic coating plant

Somçelik continues new investment in 2023.

4-13

METAL
REYONLAR
METAL
UNITS



16-17

GROSS
MARKETLER
GROSS
MARKETS



20-21

ÇELİK RAF SİSTEMLERİ
STEEL SHELVING SYSTEMS
EKO RAF SİSTEMLERİ
ECONOMIC SHELF SYSTEMS

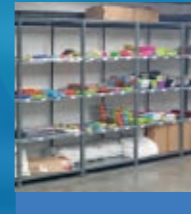

26-31

MANAV
REYONLARI
VEGETABLE
UNITS



34-43

YAZARKASA MASALARI
TURNİKE ve BARIYER
CHECKOUTS
TURNSTILE AND BARRIER



50-53

YÜK ARABALARI
RULOT
LOGISTIC TROLLEYS
ROOL CONTAINER



14-15

İNDİRİM
MARKETLERİ
DISCOUNT
MARKETS



18-19

YAPI
MARKET
DIY
MARKET



22-25

AHŞAP - BANKO
STAND - MÜŞ. KABUL
WOODEN - COUNTER
STAND - RECEPTION



32-33

UNLU MAMUL
REYONLARI
BAKERY
UNITS



44-49

MARKET
ARABALARI
SHOPPING
TROLLEYS



54-59

PROMOSYON SEPETLERİ
KONTEYNER
PROMOTION BASKETS
CONTAINER



Somçelik
RAF SİSTEMLERİ

Market Mağaza Depo Raf Sistemleri
Supermarket Store Warehouse Shelf Systems
www.somcelik.com

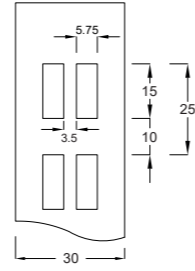

Daha Kısa Hatve Aralıkları / Shorter Pitches

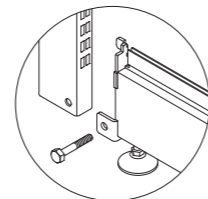
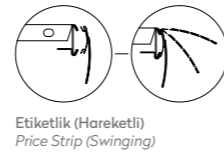
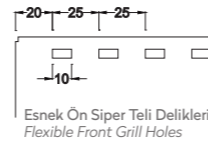
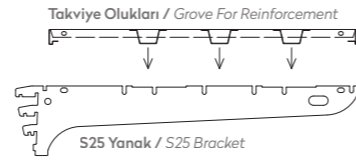

Duvar Reyonu
Wall Unit

Ölçü / Size

H: 2230 P: 300-400-500-600

L: 665-700-900-1000-1250-1330



Çiftli Orta Reyon
Double Middle Unit

Ölçü / Size

H: 1430-1630-1830 P: 300-400-500-600

L: 665-700-900-1000-1250-1330

4 Ayaklı Gross Market Reyonu
4 Leg Gross Market Unit

Kod / Code :



Yanak / Bracket
S25 140 3100+

Ön Teşhir Rafı / Front Display Shelf
S25 140 2018+

L Ayak / Base Foot
S25 140 1200+

Gondolbaşı Reyon
Head Gondole Unit

Ölçü / Size

H: 1430-1630-1830 P: 300-400-500-600

L: 665-700-900-1000-1250-1330





Daire Gondol Başı
Round Head Gondola
Kod / Code 110 5080+



Kare Stand
Square Stand
Kod / Code 210 5111+



Gondol Başı Teşhir Standı
Head Gondola Display Stand
Kod / Code 125 210 5500



Kitap Reyonu
Bookcase Unit
Kod / Code



Kitap Orta Reyonu
Bookcase Middle Unit
Kod / Code



Kitaplık Rafı (3 Katlı)
Bookcase Shelf (3 Level)
Kod / Code S25 140 2229+



Züccaciye Parfümeri Reyonu
Glassware - Perfumery Unit
Kod / Code 230 1030 230 045 090

Aksesuarlar ürüne dahil değildir / Accessory's are not included to the product

Aksesuarlar ürüne dahil değildir / Accessory's are not included to the product

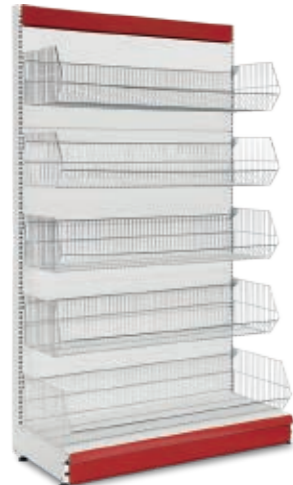

Sepet Rafli Reyon
Unit With Basket Shelf
Kod / Code



Askı Telli Reyon
Unit With Hooks
Kod / Code



Peçetelik Tek Gözlü
Napkin Holder Unit With Single Cubbyhole
Kod / Code

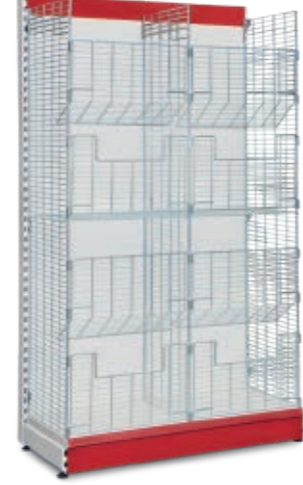

Peçetelik 4 Gözlü
Napkin Holder Unit With 4 Cubbyhole
Kod / Code



Hırdavat Reyonu
Hardware Unit
Kod / Code 125 1100+



Boru Panolu Duvar Reyonu
Unit With Pipe Panel
Kod / Code



Tel Panolu - Tel Rafli Reyon
Unit With Wire Panel - Wire Shelf
Kod / Code 125 1300+



Züccaciye Parfümeri Reyonu
Glassware - Perfumery Unit
Kod / Code 230 1010 230 045 090



ÜNİTE BAŞLIKLARI / UNIT CANOPIES

ETİKETLİKLER / LABEL HOLDERS

YÖNLENDİRME LEVHALARI / ROUTING SIGNS



S25 140 9040 039



S25 140 9141 039



140 9040 040 000



140 9040 065 000



140 9040 040 001



140 9040 040 002



140 9060+

140 9060+



150 9070 001



150 9070 002



150 9070 003

FİYATLI ETİKETLİKLER / PRICE TAG



150 9073
Ölçü / Size 27x22



150 9074
Ölçü / Size 25x17

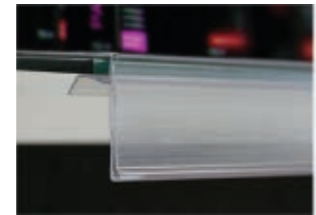

140 9090 040+



140 5510 050



125 140 5540



125 140 5520



125 140 5550



125 140 5511



125 140 5610 050



S25 140 4770 035



125 140 5500



125 140 5610 077+

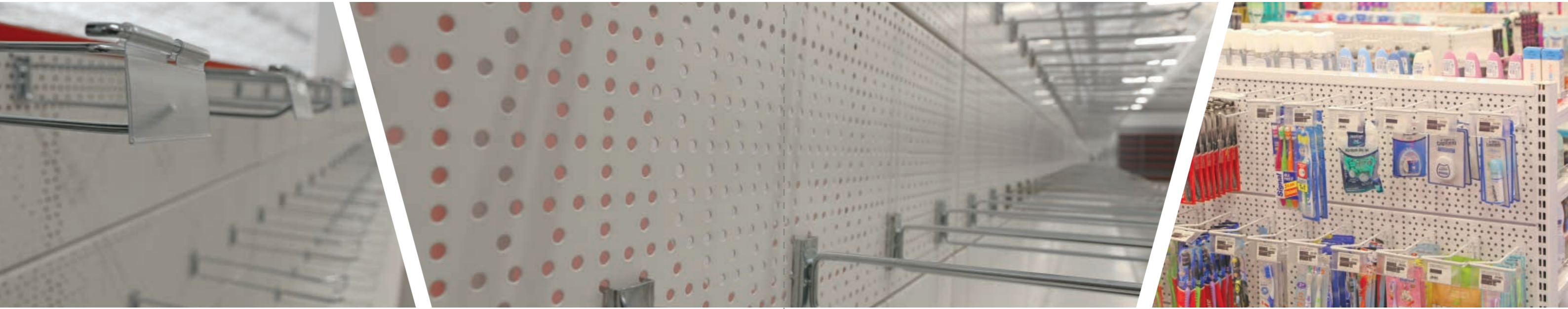

Ön Siper Teli
Front Grid
Kod / Code 150 2100 008+



Yan Siper Teli
Divider Grid
Kod / Code 150 2140 008+



Ön Siper Teli
Front Grid
Kod / Code S25 150 2100



Yan Siper Teli
Divider Grid
Kod / Code S25 150 2140



Stoper Bariyer
Stopper Barrier
Kod / Code S25 150 2430 000



Aksesuar Tutucu Profil
Accessory Holder Profile
Kod / Code S25 150 1330



Oval 'U' Askılık
Oval 'U' Hook
Kod / Code S25 150 2000



Ayakkabı Boru Rafi
Pipe Shoe Shelf
Kod / Code 150 2040



Tabak Tutucu
Plate Holder
Kod / Code 150 1090+



Kablo Kanalı
Race Way
Kod / Code 140 5913 010+



Sepet Raf
Basket Shelf
Kod / Code S25 150 1900 017



Sepet Raf
Basket Shelf
Kod / Code S25 150 1900 027



Sepet Raf Ara Bölme
Basket Shelf Divider
Kod / Code S25 150 1950 027



Sepet Raf
Basket Shelf
Kod / Code S25 150 1900 040



Sepet Raf Ara Bölme
Basket Shelf Divider
Kod / Code 150 1950 040



DP Askı Teli
DP Hook
Kod / Code 150 1021+



DP Askı Teli Etiketli
DP Hook With Label
Kod / Code 150 1002+



DP 'U' Askı Teli
DP 'U' Type Hook
Kod / Code 150 1010+



DP 'U' Askı Teli Etiketli
DP 'U' Type Hook With Label
Kod / Code 150 1011+



DP Olta Tutucu
DP Fish Hook Holder
Kod / Code 150 1040+



DP Top Tutucu Askı Teli
DP Ball Hanger Hook
Kod / Code 150 1020 000



PG Askı Teli
PG Hook
Kod / Code 150 1200+



PG Askı Teli Etiketli
PG Hook With Label
Kod / Code 150 1201+



PG 'U' Askı Teli
PG 'U' Type Hook
Kod / Code 150 1210+



PG 'U' Askı Teli Etiketli
PG 'U' Type Hook With Label
Kod / Code 150 1211+



PG Blender Tutucu
PG Blender Holder
Kod / Code 150 1200 001



PG Fön. Mak. Tut. Askı Teli
PG Hook For Hair Dryer
Kod / Code 150 1230 023



PG Ütü Tutucu Askı Teli
PG Hook For Iron
Kod / Code 150 1250



PG Kancalı Tel Askılık
PG Wire Hooked Hanger
Kod / Code 150 1280



PG Hilal Boncuklu Askılık
PG Hook With Beads
Kod / Code 120 1260



PG Hortum Tutucu
PG Pipe Holder
Kod / Code 150 4000



PG Merdiven Askılık
PG Stairs Hook
Kod / Code 150 1270



PG Boru Eğri Askılık
PG Pipe Inclined Arm
Kod / Code 150 1311 037



PG Boru Düz Askılık
PG Pipe Inclined Arm
Kod / Code 150 1311 001



PG 'Z' Askılık (Boncuksuz)
PG 'Z' Hooks (Without Beads)
Kod / Code 150 1310 001



KP Askı Teli
KP Hook
Kod / Code 150 1100



KP Askı Teli Etiketli
Kp Hook With Label
Kod / Code 150 1101



KP 'U' Askı Teli
KP 'U' Type Hook
Kod / Code 150 1110t



KP 'U' Askı Teli Etiketli
KP 'U' Type Hook With Label
Kod / Code 150 1111t



KP Top Tutucu Askı Teli
KP Ball Hanger Hook
Kod / Code 150 1120 000 030

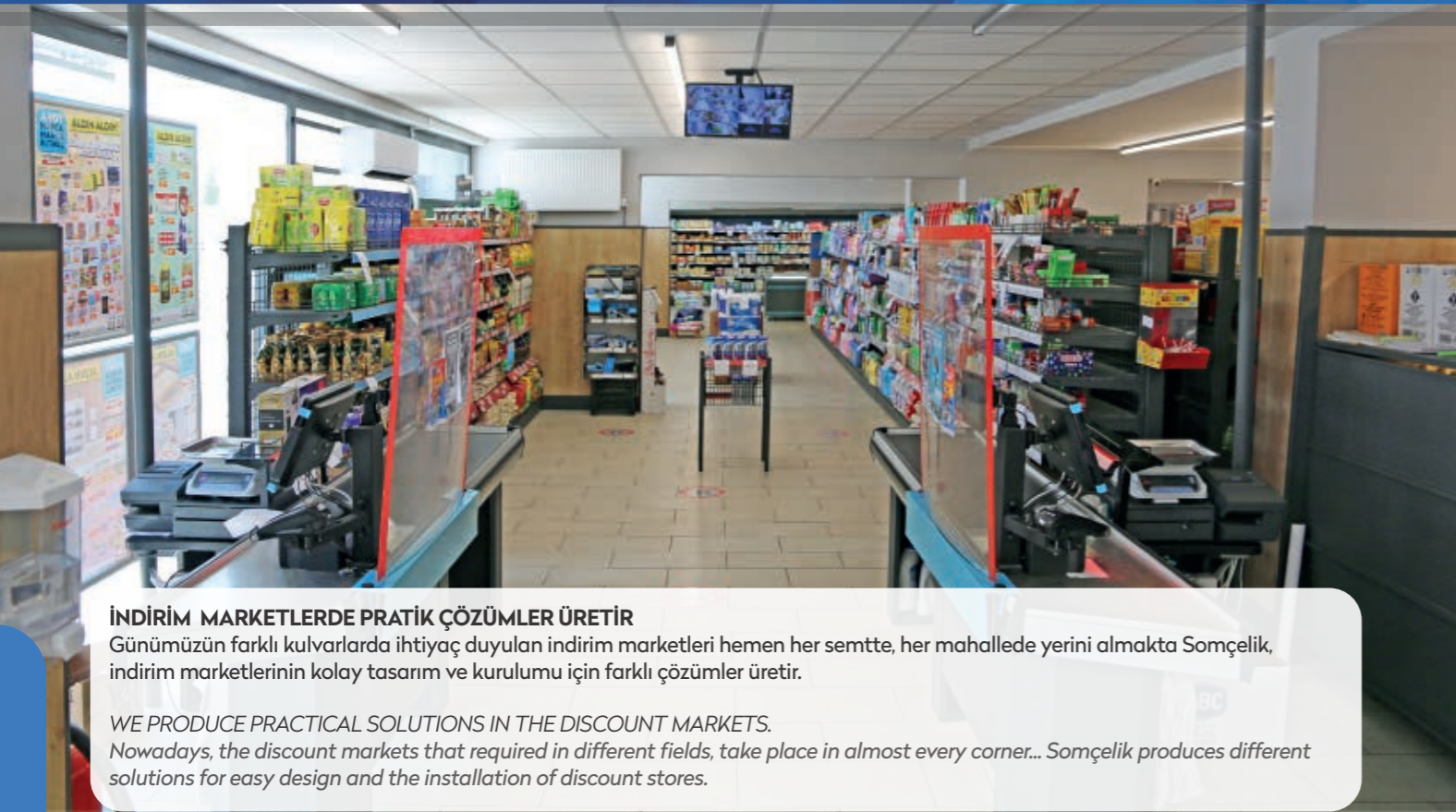

İNDİRİM MARKETLERDE PRATİK ÇÖZÜMLER ÜRETİR

Günümüzün farklı kulvarlarda ihtiyaç duyulan indirim marketleri hemen her semtte, her mahallede yerini almakta Somçelik, indirim marketlerinin kolay tasarım ve kurulumu için farklı çözümler üretir.

WE PRODUCE PRACTICAL SOLUTIONS IN THE DISCOUNT MARKETS.

Nowadays, the discount markets that required in different fields, take place in almost every corner... Somçelik produces different solutions for easy design and the installation of discount stores.





Farklı kombinasyonları ile geniş kullanım alanına sahip Gross Market Raf Sistemleri Endüstriyel Mağazalarda, Gross Marketlerde ve benzeri yerlerde direk teşhir amaçlı olarak kullanılabilir. Farklı kombinasyonları ile geniş kullanım alanına sahip Gross Market Raf Sistemleri Endüstriyel Mağazalarda, Gross Marketlerde ve benzeri yerlerde direk teşhir amaçlı olarak kullanılabilir.

Aynı anda hem depo hemde teşhir amaçlı kullanılarak alanınız da dikey doğrultuda daha çok verimlilik elde edilir ve bunu yaparken de görsellikten taviz vermek zorunda kalmazsınız...

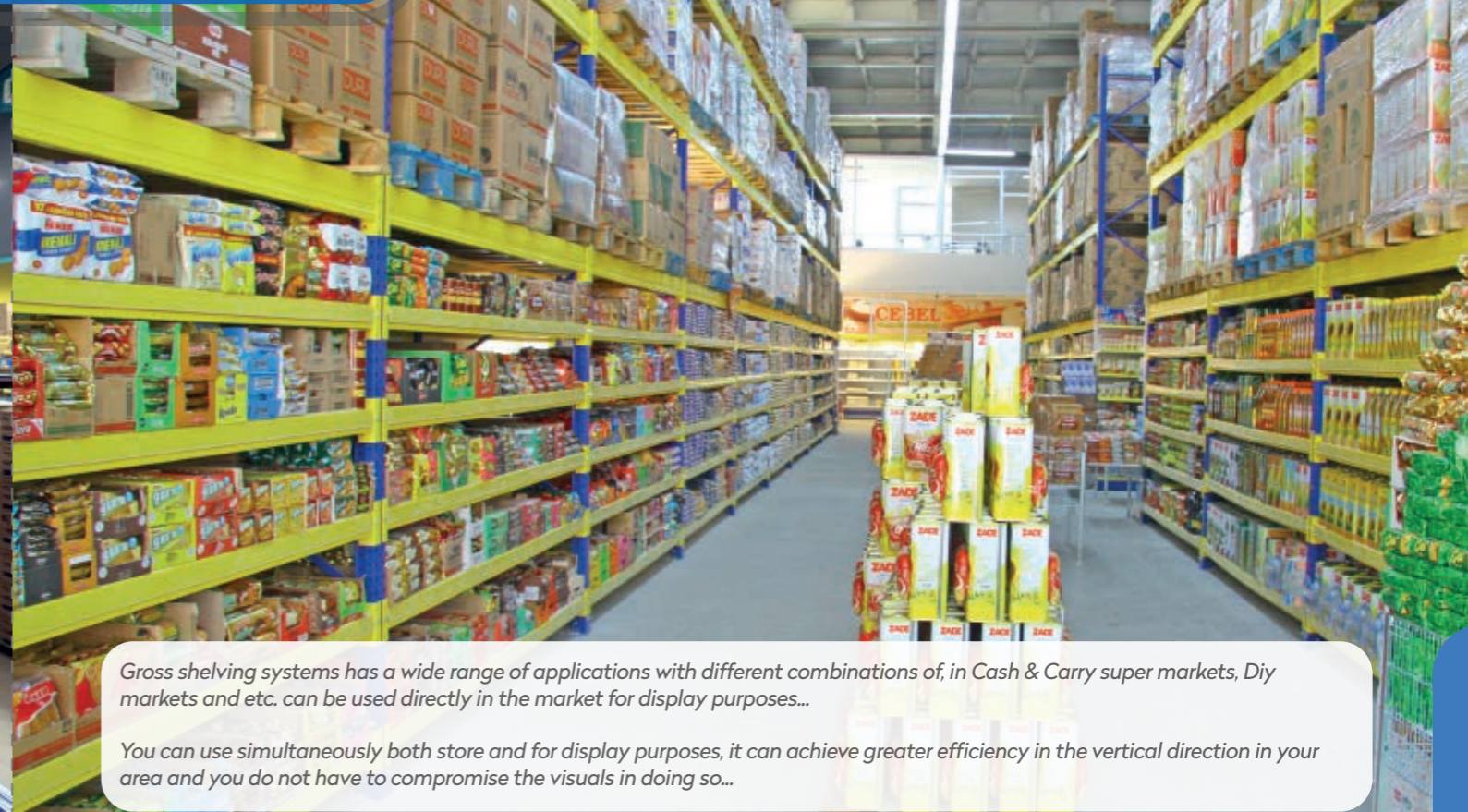

Gross shelving systems has a wide range of applications with different combinations of, in Cash & Carry super markets, Diy markets and etc. can be used directly in the market for display purposes...

You can use simultaneously both store and for display purposes, it can achieve greater efficiency in the vertical direction in your area and you do not have to compromise the visuals in doing so...







EKO RAF SİSTEMLERİ ECONOMIC SHELF SYSTEMS



Tek Delikli Profil
Single Hole Profile
Kod / Code 140 1031+

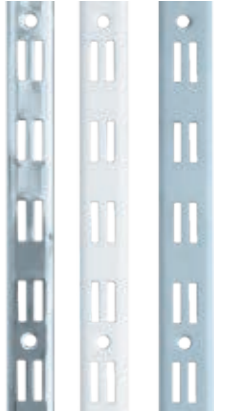

Çift Delikli Profil
Double Hole Profile
Kod / Code 140 1032+



Eko Yanak (Ahşap)
Economical Bracked (Wooden)
Kod / Code 140 3211-3212



Eko Yanak
Economical Bracked
Kod / Code 140 3200



Eko Raf
Economical Shelf
Kod / Code 140 2101

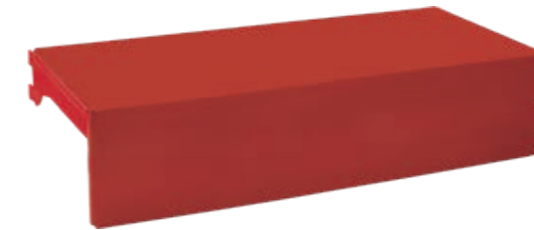

Bazalı Eko Raf
Economical Plinth Shelf
Kod / Code 140 2110



Etiketlik
Label Holder
Kod / Code 140 9050





MÜŞTERİ KABUL MASALARI
RECEPTION DESK

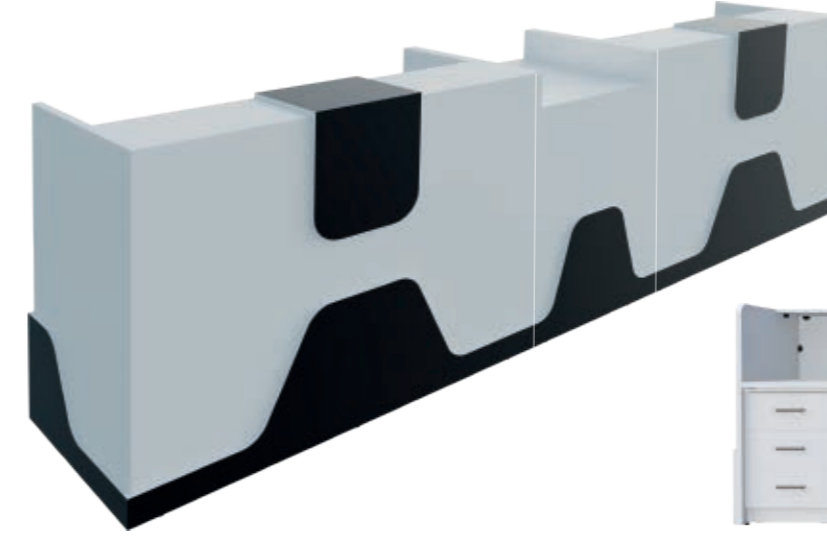

MK 150-1
Kod / Code 190 1070 115 070 150
Ölçü / Size 1150x700x1500
MK 150-2
Kod / Code 190 1070 115 070 070
Ölçü / Size 1150x700x700

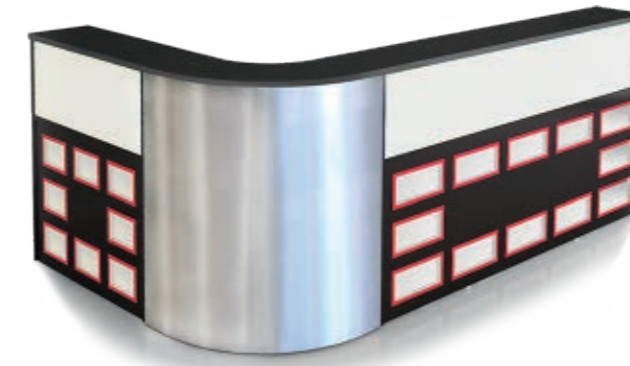

MK 010
Kod / Code 190 1000 114 070 230
Ölçü / Size 1150x1600x2700

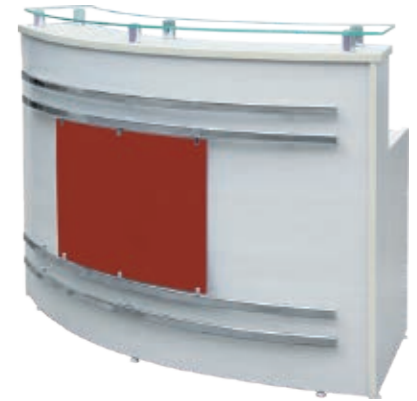

MK 100
Kod / Code 190 1050 114 070 170
Ölçü / Size 1170x850x1670



Mağaza Sistemleri Tip-01
Store - Systems Type-01
Kod / Code 125 5430



Mağaza Sistemleri Tip-02
Store - Systems Type-02
Kod / Code 125 1430

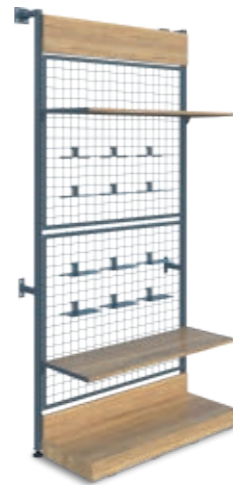

Mağaza Sistemleri Tip-03
Store - Systems Type-03
Kod / Code 125 1300 040 100 001



Mağaza Sistemleri Tip-04
Store - Systems Type-04
Kod / Code 180 1121 225 045 070 000



Mağaza Sistemleri Tip-05
Store - Systems Type-05
Kod / Code 125 1100 040



Mağaza Sistemleri Tip-06
Store - Systems Type-06
Kod / Code 180 1121 223



MK 160-1

MK 160-2

MK 160-3

MK 160-1	Kod / Code 190 1090 090
	Ölçü / Size 900x700x1400
MK 160-2	Kod / Code 190 1090 105
	Ölçü / Size 1050x700x600
MK 160-3	Kod / Code 190 1090 090
	Ölçü / Size 900x700x600



MK 170
Kod / Code 190 1100 115 075 200
Ölçü / Size 1150x750x2000

Aksesuarlar ürüne dahil değildir / Accessory's are not included to the product



BN - 220
Kod / Code 210 1150 090 060 100
Ölçü / Size 910x600x1200



BN - 050
Kod / Code 200 3010 120 056 113
Ölçü / Size 1200x560x1130



BN - 40
Kod / Code 200 3010 090 060 100
Ölçü / Size 900x600x1000



BN - 080
Kod / Code 200 3010 090 084 126
Ölçü / Size 900x840x1260



BN - 130
Kod / Code 200 3010 123 078 123
Ölçü / Size 1230x780x1230

Akrobat Orta Askılıklar
Acrobat Middle Hanger



ASO - 020
210 5100 150



ASO - 020
210 5080 150



AST - 014
Kod / Code 110 2300 150 074 208
Ölçü / Size 1500x740x2080



AST - 015
Kod / Code 110 2300 165 060 196
Ölçü / Size 1650x600x1960



AST - 016
Kod / Code 110 2300 160 066 120
Ölçü / Size 1200x660x1200

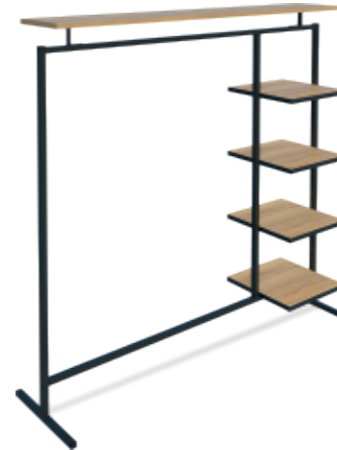

AST - 017
Kod / Code 210 5000 135 030 120
Ölçü / Size 1350x300x1200



AST - 270
Kod / Code 210 4060 120 150 150
Ölçü / Size 1200x1500x1500

Çapraz Orta Askılıklar
Cross Middle Hangers



'Z' Tipi / Type
210 5040



'T' Tipi / Type
210 5050

Aksesuarlar ürüne dahil değildir / Accessory's are not included to the product

Aksesuarlar ürüne dahil değildir / Accessory's are not included to the product



Şemsiye Ünitesi / Umbrella Stand
Kod / Code 210 4040 250 090 110
Ölçü / Size 1300x500x900



Ahşap Ünite / Wooden Unit
Kod / Code 180 1121 050
Ölçü / Size 2170x500x1650



Orta Askılık / MH Type - 1
Kod / Code 210 5320 151
Ölçü / Size 1550x800x800



Orta Askılık Çiftli / MH Type - 2
Kod / Code 210 5000 145
Ölçü / Size 1450x620x1290t



Orta Askılık Tekli / MH Type - 3
Kod / Code 210 5015 140
Ölçü / Size 1400x600x1100



'I' Tipi / Type
210 5020



'S' Tipi / Type
210 5030



Çam Manav (120)
Wooden Fruit and Vegetable Unit (120)

Kod / Code	Ölçü / Size
120 1090 120 230+	H:2300 P:1270 L:900-1000-1250



Çam Manav Tekli Orta (120)
Wooden Fruit and Vegetable Single Side Middle Unit (120)

Kod / Code	Ölçü / Size
120 1191 120 145	H:1450 P:1270 L:900-1000-1250



Çam Manav Çatılı Çiftli Orta Stand
Wooden Fruit and Vegetable Double Side Stand

Kod / Code	Ölçü / Size
120 4000 150	H:1150 P:1500 L:2500



Çam Manav Gondolbaşı Stand
Wooden Fruit and Vegetable Head Gondola

Kod / Code	Ölçü / Size
120 5000 095 068 136	H:950 P:680 L:1360



Çam Manav (80)
Wooden Fruit and Vegetable Unit (80)

Kod / Code	Ölçü / Size
120 1090 080 230+	H:2300 P:920 L:900-1000-1250



Çam Manav Tekli Orta (80)
Wooden Fruit and Vegetable Single Side Middle Unit (80)

Kod / Code	Ölçü / Size
120 1191 080 145	H:1450 P:920 L:900-1000-1250



Çam Manav Orta Stand (80)
Wooden Fruit and Vegetable Middle Stand (80)

Kod / Code	Ölçü / Size
120 4000 095 000 080	H:950 P:800 L:800



Çam Manav Orta Stand (120)
Wooden Fruit and Vegetable Middle Stand (120)

Kod / Code	Ölçü / Size
120 4000 095 000 120	H:950 P:1200 L:1200



Çam Manav Rafli
Wooden Fruit and Vegetable Unit With Shelf

Kod / Code	Ölçü / Size
120 2021 110 213	H:2300 P:800 L:1000-1250

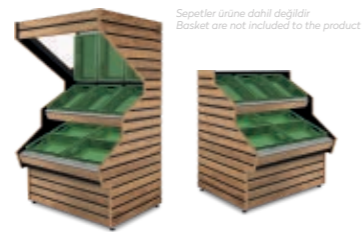

Çam Manav Rafli Tekli Orta
F&V Single Side Middle Unit With Shelf

Kod / Code	Ölçü / Size
120 2001 110 160	H:1600 P:800 L:1000-1250



Çam Manav Terazi Bankosu
Wooden Counter Scales

Kod / Code	Ölçü / Size
230 5090 090 050 120	H:900 P:500 L:1200



Çam Manav Terazi Bankosu - Kulaklı
Wooden Counter Scales Double Sided

Kod / Code	Ölçü / Size
230 5090 090 045 113	H:900 P:450 L:1150



Manav Reyonu Tip-11
Vegetable Unit Type-11

Kod / Code	Ölçü / Size
120 2011 110 000 213+	H:2150 P:1100 L:1000-1250

Sepetler ürüne dahil değildir
Basket are not included to the product



Manav Reyonu Tip-01
Vegetable Unit Type-01

Kod / Code	Ölçü / Size
120 2020 225 095+	H:2250 P:950 L:700-900-1000

Sepetler ürüne dahil değildir
Basket are not included to the product



Manav Reyonu Tip-14
Vegetable Unit Type-14

Kod / Code	Ölçü / Size
120 1090 228 120 125	H:2280 P:1200 L:1250

Sepetler ürüne dahil değildir
Basket are not included to the product



Manav Reyonu Tip-12
Vegetable Unit Type-12

Kod / Code	Ölçü / Size
129 3000 185 055 125	H:1850 P:550 L:1250

Sepetler ürüne dahil değildir
Basket are not included to the product



Metal Manav Reyonu
Metal Fruit and Vegetable Stand

Kod / Code	Ölçü / Size
120 1020 223 060 100 002	H:2230 P:600 L:1000

Sepetler ürüne dahil değildir
Basket are not included to the product



Manav Reyonu Tip-13
Vegetable Unit Type-13

Kod / Code	Ölçü / Size
129 3030 185 055 125	H:1850 P:1100 L:1250

Sepetler ürüne dahil değildir
Basket are not included to the product



Sepetler ürüne dahil değildir
Basket are not included to the product

Manav Reyonu Tip-04
Vegetable Unit Type-04

Kod / Code	Ölçü / Size
120 1030 225 080+	H:1750-2250 P:800 L:600-1200-1800



Sepetler ürüne dahil değildir
Basket are not included to the product



Tel Rafli Manav Reyonu Tip-07
Wire Shelf Vegetable Unit Type-07

Kod / Code	Ölçü / Size
120 3030 176 100 080	H:1760 P:1000 L:900



Sepetler ürüne dahil değildir
Basket are not included to the product

Manav Reyonu Tip-05
Vegetable Unit Type-05

Kod / Code	Ölçü / Size
120 1040 135 160+	H:1350-1750 P:1800 L:600-1200-1800



Ahşap Terazi Bankosu
Wooden Scale Bank

Kod / Code	Ölçü / Size
230 3090 090 045 115	H:900 P:450 L:1150



Profil Terazi Bankosu
Profile Scale Bank

Kod / Code	Ölçü / Size
230 3100 090 050 050	H:900 P:500 L:500



Plastik Sepet
Plastic Basket

Kod / Code	Ölçü / Size
140 9002 015 040 060	H:150 P:600 L:400



Sepetler ürüne dahil değildir
Basket are not included to the product



Manav Reyonu Tip-08
Vegetable Unit Type-08

Kod / Code	Ölçü / Size
120 1070 160 070 120	H:1600 P:700 L:1200

Poşet Askılıkları



Kod / Code
140 4810 014 016 028+



Kod / Code
140 4806 005 005 025



Kod / Code
140 4605 000 000 110

Hook For Bags



Kod / Code
140 4806 005 005 020



Kod / Code
140 4809 014 016 028+



Unlu Mamül Reyonu Tip-1
Bakery Unit Type-1

Kod / Code	Ölçü / Size
130 1000 225 060	H:2250 P:600 L:900



Unlu Mamül Reyonu Tip-2
Bakery Unit Type-2

Kod / Code	Ölçü / Size
130 1020 225 060	H:2250 P:600 L:900



Dolaplı Ekmek Ünitesi Tip-7
Bakery Unit With Cupboard Type-7

Kod / Code	Ölçü / Size
130 1007 223 000	H:2230 P:500 L:1000



Ekmek Ünitesi Tip-11
Bakery Unit Type-11

Kod / Code	Ölçü / Size
130 1070 193 071 100	H:1930 P:710 L:1000



Ekmek Ünitesi Tip-12
Bakery Unit Type-12

Kod / Code	Ölçü / Size
130 1071 183 070 100	H:1830 P:700 L:1000



Unlu Mamül Reyonu Tip-6A
Bakery Unit Type-6A

Kod / Code	Ölçü / Size
130 1070 225 055	H:1530 P:550 L:900



Unlu Mamül Reyonu Tip-6B
Bakery Unit Type-6B

Kod / Code	Ölçü / Size
130 1080 225 055	H:1530 P:550 L:700-900



Ekmek Ünitesi Tip-8
Bakery Unit Type-8

Kod / Code	Ölçü / Size
130 1070 203 060 100	H:2030 P:600 L:1000



Ekmek Ünitesi Tip-9
Bakery Unit Type-9

Kod / Code	Ölçü / Size
130 1071	H:2030-1630 P:600 L:900-1000



Ekmek Ünitesi Tip-10A
Bakery Unit Type-10A

Kod / Code	Ölçü / Size
111 1039 185 060 090	H:1850 P:600 L:900

Ekmek Ünitesi Tip-10B
Bakery Unit Type-10B

Kod / Code	Ölçü / Size
110 1040 185 060 090	H:1850 P:600 L:900



PLANET MIRROR
PLANET MIRROR (FLAT)

Bantlı / With Transport Band 160 8000+



Düz/Flat

PLANET / PLANET

Bantlı / With Transport Band 160 5011+
Bantsız / Without Transport Band 160 4012+



Oval/Oval

PLANET / PLANET

Bantlı / With Transport Band 160 6011+
Bantsız / Without Transport Band 160 6012+



Düz/Flat



Oval/Oval



Bantlı / With Transport Band



Bantsız / Without Transport Band

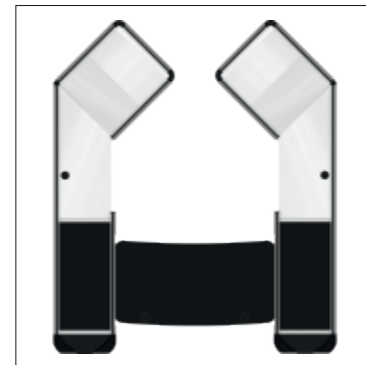
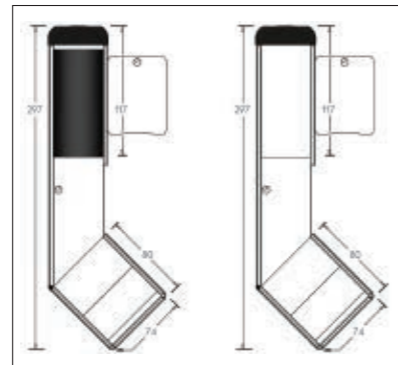

AURA / AURA

Bantlı / With Transport Band 160 4002+
Bantsız / Without Transport Band 160 4001+



AURA / AURA

Bantlı / With Transport Band 160 3002+
Bantsız / Without Transport Band 160 3001+

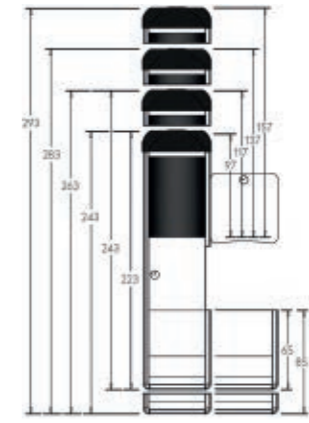
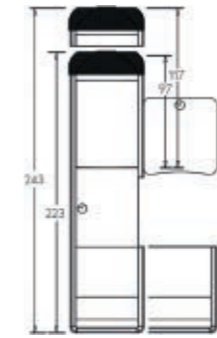

L Tipi / Type



U Tipi / Type



Bantlı
With Transport Band



Bantsız
Without Transport Band



Sol
Left



Sağ
Right



EKSPRES / EXPRESS

Bantlı / With Transport Band		
U (Tipi/Type) Sağ/Right	160 5001	
U (Tipi/Type) Sol/Left	160 5002	
L (Tipi/Type) Sağ/Right	160 6001	
L (Tipi/Type) Sol/Left	160 6002	

Bantsız / Without Transport Band		
U (Tipi/Type) Sağ/Right	160 7001	
U (Tipi/Type) Sol/Left	160 7002	
L (Tipi/Type) Sağ/Right	160 8001	
L (Tipi/Type) Sol/Left	160 8002	



U Tipi Bantlı
U Type With Transport Band



U Tipi Bantsız
U Type Without Transport Band

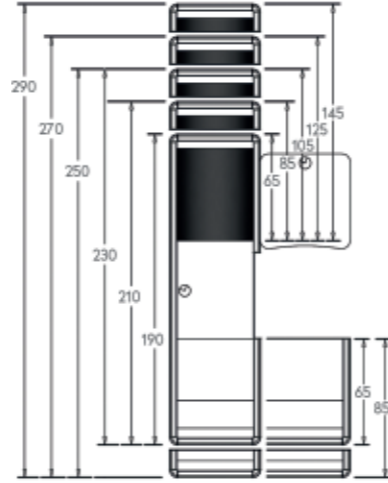

OVAL BLANKA / OVAL BLANCA

Bantlı / With Transport Band		
U (Tipi/Type) Sağ/Right	162 2001	
U (Tipi/Type) Sol/Left	162 2002	
L (Tipi/Type) Sağ/Right	162 1001	
L (Tipi/Type) Sol/Left	162 1002	

Bantsız / Without Transport Band		
U (Tipi/Type) Sağ/Right	162 3001	
U (Tipi/Type) Sol/Left	162 3002	
L (Tipi/Type) Sağ/Right	162 4001	
L (Tipi/Type) Sol/Left	162 4002	



U Tipi Bantlı
U Type With Transport Band



U Tipi Bantsız
U Type Without Transport Band

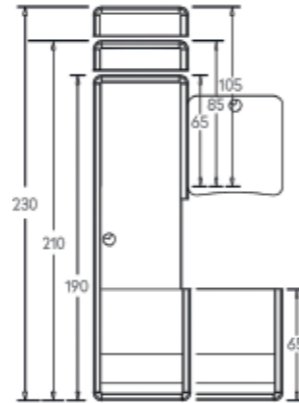

DÜZ BLANKA / FLAT BLANCA

Bantlı / With Transport Band		
U (Tipi/Type) Sağ/Right	162 5001	
U (Tipi/Type) Sol/Left	162 5002	
L (Tipi/Type) Sağ/Right	162 6001	
L (Tipi/Type) Sol/Left	162 6002	

Bantsız / Without Transport Band		
U (Tipi/Type) Sağ/Right	162 7001	
U (Tipi/Type) Sol/Left	162 7002	
L (Tipi/Type) Sağ/Right	162 8001	
L (Tipi/Type) Sol/Left	162 8002	



U Tipi Bantlı
U Type With Transport Band



U Tipi Bantsız
U Type Without Transport Band



EKSPRES TENDOM EKSPRES TANDEM

Bantlı / With Transport Band	165 3000
Bantsız / Without Transport Band	165 4000
L (Tipi / Type)	



OVAL BLANCA TENDOM OVAL BLANCA TANDEM

Bantlı / With Transport Band	165 1001
Bantsız / Without Transport Band	165 4001
L (Tipi / Type)	

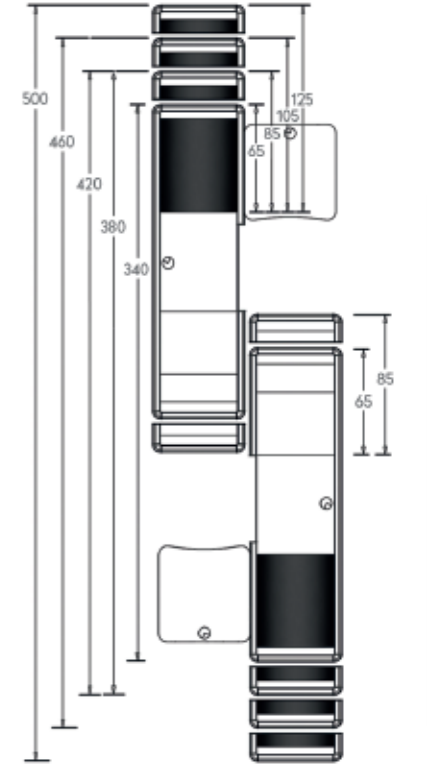

DÜZ BLANCA TENDOM FLAT BLANCA TANDEM

Bantlı / With Transport Band	165 6001
Bantsız / Without Transport Band	165 8001
L (Tipi / Type)	

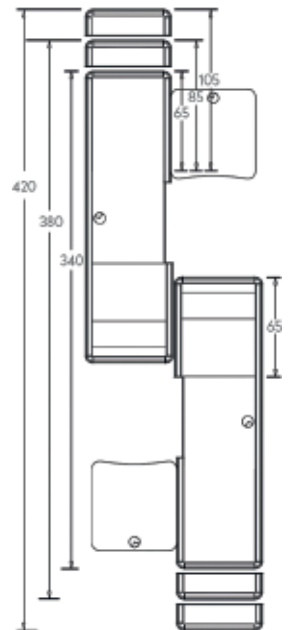
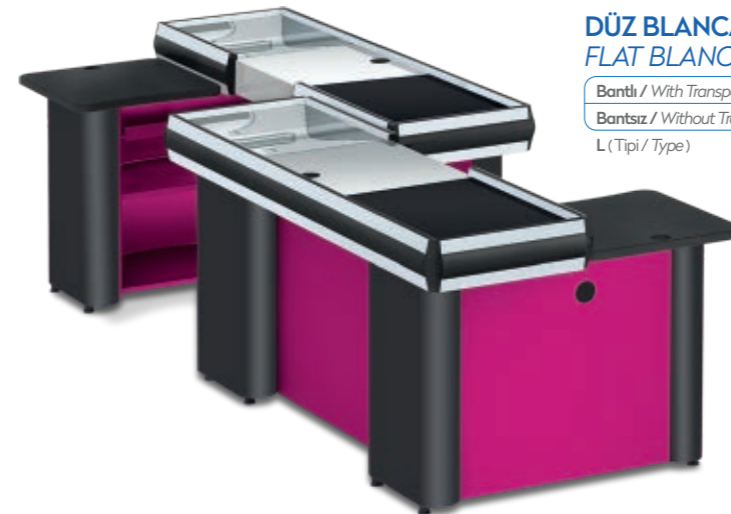



TRANSİT
TRANSİT

Bantsız / Without Transport Band	
L (Tipi / Type) Sağ / Right	163 5001
L (Tipi / Type) Sol / Left	163 5002



TRANSİT
TRANSİT

Bantlı / With Transport Band	
L (Tipi / Type) Sağ / Right	164 5001
L (Tipi / Type) Sol / Left	164 5002



MİGAL KASA
MIGAL CHECKOUT

Bantlı / With Transport Band	
160 000 000 001 380	

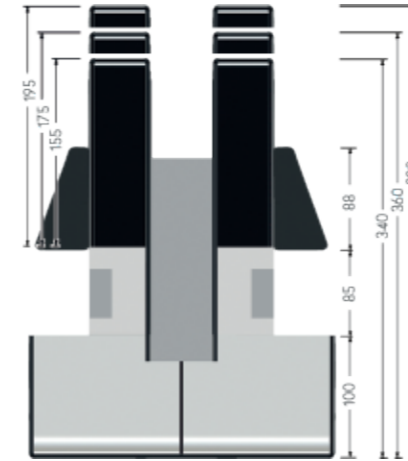

NEV KASA
NEV CHECKOUT

Bantlı / With Transport Band	
160 000 000 000	



Yazar Kasa Masası Aksesuarları Checkout Accessories

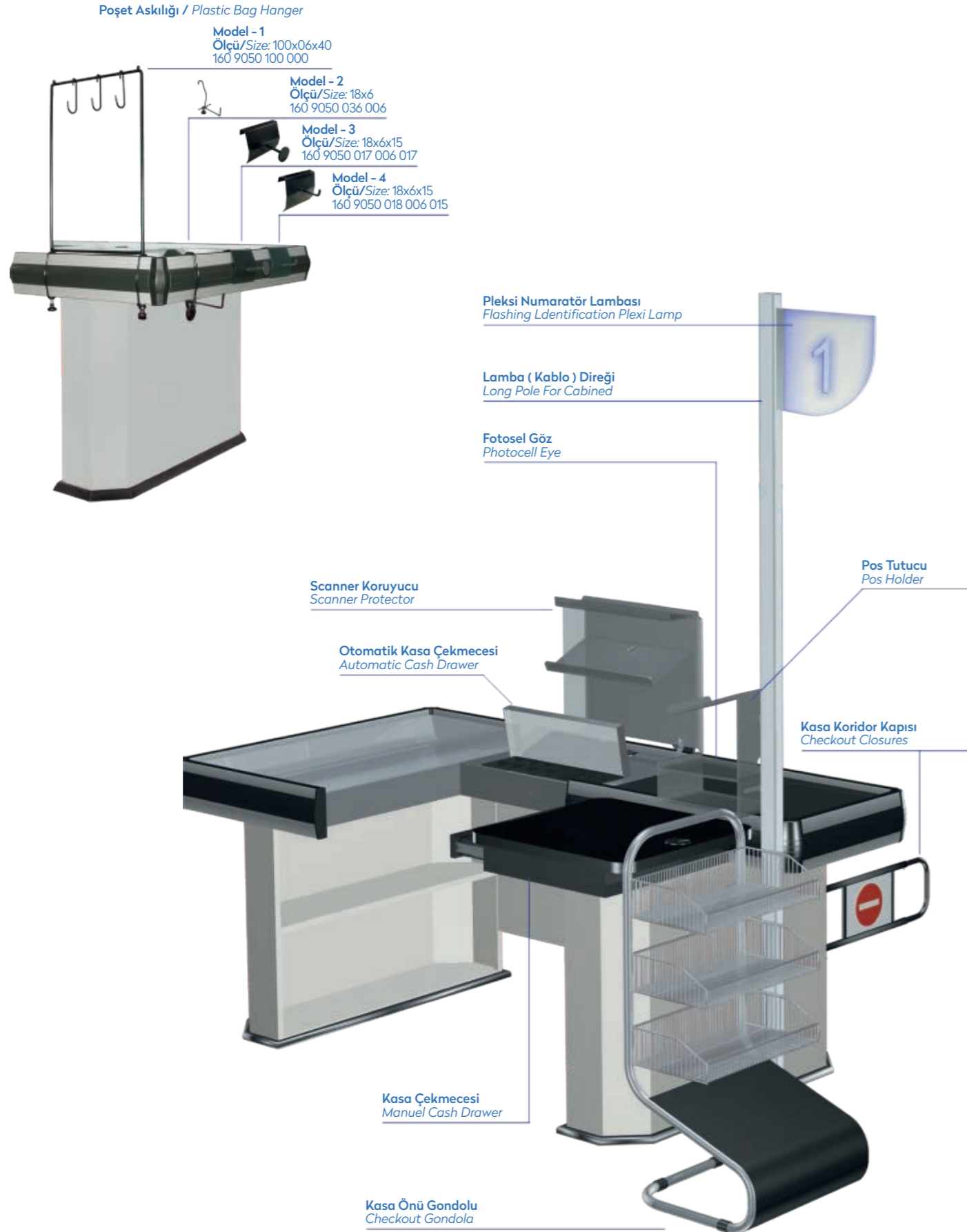

Pleksi Numaratör Lambası
Flashing Identification Plexi Lamp
160 9092 030 030
30x30



Alüminyum Lamba (Kablo) Direği
Aluminum Long Pole For Cabined
166 5515 280
280x4x8



Lamba (Kablo) Direği
Long Pole For Cabined
160 9020 280 006
280x6x6

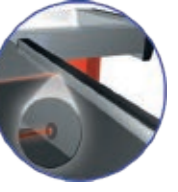

Fotosel Göz
Photocell Eye
166 9013



Pos Tutucu
Pos Holder
160 9093 035 029 018
35x29x18

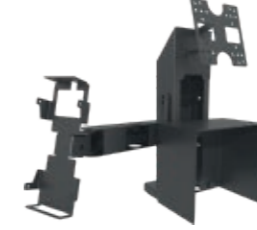

Robot Kol Takımı
Pos Holder (Robotic)
140 9091 000 000 002



Scanner Koruyucu
Scanner Protector
166 9096 045 017 044
45x17x44



Kasa Çekmecesi
Manuel Cash Drawer
160 9010 010 040 048
9x45x51



Otomatik Kasa Çekmecesi
Automatic Cash Drawer
160 9010 008 046 017
9x17x46



Bir Sonraki Müşteri
Next Customer
164 5518



Poşet Arabası
Carrier For Plastic Bags
160 9030 072 075 038
72x75x38



Kasa Koridor Kapısı
Checkout Closures
160 9040 020 055 000
20x55x80



Poşetlik
Bag Hangers
140 4500 200
56x13x40



Yazarkasa Standı Tek Yönlü
Checkout Stand Single Side
S25 110 9000 123 093+ 123x40x100



Kasa Önü Gondolu
Checkout Gondola
160 9050 110 062 110x62x60



Kasa Önü Gondolu
Checkout Gondola
160 9050 095 037 050 100x44x48



Fotoselli Turnike
Motorised Swing Gate With Photocell

Kod / Code	Ölçü / Size
170 1030 107 150 150 002	1170x2130x2450



Döner Turnike
Turnstile

Kod / Code	Ölçü / Size
Sağ / Right 170 1001 107 055 140	1060x1050x500
Sol / Left 170 1002 107 055 140	1060x1050x500



Çarpma Turnike
Swing Gate

Kod / Code	Ölçü / Size
Sağ / Right 170 1011 107 020 070	1070x800x180
Sol / Left 170 1012 107 020 070	1070x800x180



	Kod / Code	Ölçü / Size
01 Tek Yönlü Diğeç / Single Side Upright	170 2010 107+	1060x180x110
02 Köşe Diğeç / Corner Upright	170 2030 107+	1060x180x110
03 Çift Yönlü Diğeç / Double Side Upright	170 2020 107+	1060x180x110
04 Bariyer Ara Boru / Barrier Connecting Pipe	170 2050	Ø 40



	Kod / Code	Ölçü / Size
A1 Yer Bariyeri Bağlantı Elemanı / Floor Barrier Connection Elements	170 4020 015	
A2 Yer Bariyeri Profili / Floor Barrier Profile	170 4010 004+	Ø 32



	Kod / Code	Ölçü / Size
B1 Yer Bariyeri Bağlantı Elemanı / Floor Barrier Connection Elements	170 3020 015+	
B2 Yer Bariyeri Profili / Floor Barrier Profile	170 3010 004+	
B3 Yer Bariyer Bitim / Floor Barrier End	170 3040 004+	



Bebe Seti / Baby Seat

LEYLAK

Market Arabası / Shopping Trolley

Bebe Setsiz / Without Baby Seat	220 1120
Bebe Setli / With Baby Seat	220 1130



YAPI MARKET / DIY MARKET

Market Arabası / Shopping Trolley

70 LT	220 1900 070
130 LT	220 1900 130
160 LT	220 1900 160



Bebe Seti / Baby Seat

MENEKŞE

Market Arabası / Shopping Trolley

Bebe Setsiz / Without Baby Seat	220 1320
Bebe Setli / With Baby Seat	220 1330



ORKİDE

Market Arabası / Shopping Trolley

220 1320	Bebe Setsiz / Without Baby Seat
220 1330	Bebe Setli / With Baby Seat



STEELCAR

Market Arabası / Shopping Trolley

Bebe Setsiz / Without Baby Seat	220 1130
Bebe Setli / With Baby Seat	220 1130



Bebe Seti / Baby Seat



BALERİN

Market Arabası / Shopping Trolley

25 LT	220 1620 025
40 LT	220 1620 040

JUNIOR

Market Arabası / Shopping Trolley

25 LT	220 1520 025
-------	--------------

SOMCAR

Market Arabası / Shopping Trolley

90 LT	220 1720 090
-------	--------------



PLASTİK MARKET ARABASI PLASTIC SHOPPING TROLLEY



Bebe Setli / With Baby Seat
220 3021 100 000 000



100 LT



Bebe Setli / With Baby Seat
220 4021 000 000 100



AKSESUARLAR ACCESSORIES



STANDART TEKER STANDARD WHEEL

Teker Özellikleri / Wheel Specifications

- Bilyalı rulman teker / Roller bearing wheel
- Preslenmiş sac gövde / Pressed sheet body
- Beyaz çinko kaplama / White zinc covered
- Rulman bağlantı / Roller bearing connection
- Teker gövdesi enjeksiyonlu plastik / Wheel body made of injection plastic
- Teker sırtı siyah lastik / Back of wheel made black rubber



Teker / Wheel (100 mm)
Kapasite / Capacity : 70 kg
Çap / Diameter : 100 mm
220 9023 003



Teker / Wheel (100 mm)
Kapasite / Capacity : 90 kg
Çap / Diameter : 100 mm
220 9023 005



Teker / Wheel (125 mm)
Kapasite / Capacity : 90 kg
Çap / Diameter : 125 mm
220 9023 004

YÜRÜYEN BAND TEKERİ / ESCALATOR WHEEL

125'lik Teker Fren Mekanizması
Fren mekanizması; Gövde kendinden poliüretan kaplamalıdır. Gövde çıkıntısı zemine 90° açı ile basarak çalışan bir mekanizmaya sahiptir.

Frenin çalışma şekli; Ruletin Diskleri yürüyen merdivenin bant kanallarına girdiğinde çıkıntı şeklinde olan gövdedeki fren tutucu poliüretan parça merdiven tepe noktasına basması ile frenleme sağlanır.



Tip - 1 / Type - 1 (125 mm)
Kapasite / Capacity : 80 kg
Çap / Diameter : 125 mm
220 9235 001

125 mm Diameter Frake Mekanizma
The explanation of the frake mechanism; The body is made and covered, designed by polyurethane wich the shopping trolley will push in upright position (90 Degres) to the floor.

The work of the mechanism will be as; When the tailor of the wheel is entering the canals of the escelator, accordingly one self the frake pedal (made of poliurethane) will press and by this way will the frake procured from self.

AKSESUAR ÖZELLİKLERİ / ACCESSORY SPECIFICATION

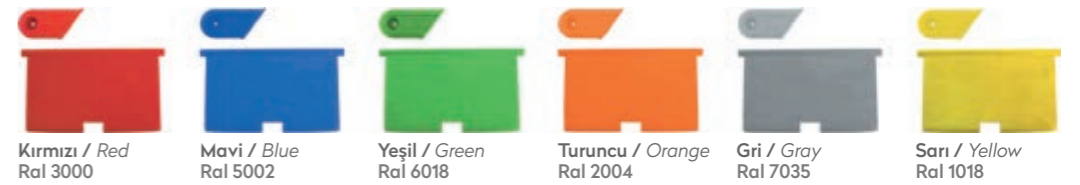

Bebe Seti Emniyet Kemerini
Safety Belt For Baby Seat
220 9012



Afiş Panosu
Advertisement Panel
220 9020



Kilit Sistemi
Deposit Lock System
220 9019



Özel Kulp Yazısı
Special Advertising Handle
220 9010



Ön Torba Askısı
Bag Hook
220 9013



Bebe Seti Plastiği
Baby Seat Plastic
220 9011



Kilit Sistemi (Plastik Market Arabası)
Deposit Lock System (Plastic Shopping Trolley)
220 9120

- 80 kg Taşıma Kapasitesi
80 kg Carrying Capacity
- Hafif - Kompakt
Lightweight - Compact
- Kilit Sistemi
Deposit Lock System
- %100 Geri Dönüşümlü
%100 Recyclable
- Ergonomik - Sessiz
Ergonomic - Silent
- Bebe Seti
With Baby Seat
- Antibakteriyel Kulp
Antibacterial Handle
- Kolay Temizlik
Easy Cleaning
- İstenilen Renkte Üretim
Different Color Options
- UV8 Sertifikalı Boya Solmaz - Çatlamaz
UV8 Certified Paint No Fades - Cracks
- Rahat Kullanım
Comfortable Usage
- Yürüyen Band Teker
Escalator Wheel





% 100 yerli üretim olan venüs plastik el sepeti, modern ve ergonomik tasarımı ile dikkatleri üzerine çekiyor.

Venüs plastik el sepeti 28 litrelik hacmi ve geniş renk yelpazesi ile sizlere sunuluyor.

Hafif yapısı ve sağlamlığının yanı sıra çevre dostu olması venüs plastik el sepetinin tercih edilmesinde etkili bir rol oynuyor.

Venus plastic hand basket, which is 100% domestic production, draws attention with its modern and ergonomic design.

Venus plastic hand basket is offered to you with a volume of 28 liters and a wide range of colors.

In addition to its light structure and durability, its environmental friendliness plays an effective role in the preference of the Venus plastic hand basket.



Venüs Plastik El Sepeti
Venus Plastic Hand Basket

Kod / Code	Ölçü / Size
220 3121 000+	28 LT



Venüs Plastik El Sepeti Altık
Venus Plastic Hand Basket Holder

Kod / Code	Ölçü / Size
220 2063 000 028+	28 LT



Plastik El Sepeti (Tekerlekli)
Plastic Hand Basket With Wheels

Kod / Code	Ölçü / Size
220 3030 043 037 053	43 LT



Tel El Sepeti
Wire Hand Basket

Kod / Code	Ölçü / Size
210 3011	20 LT



Plastik El Sepeti
Plastic Hand Basket

Kod / Code	Ölçü / Size
220 3020	20 LT



El Sepeti Altık
Shopping Basket Holder

Kod / Code	Ölçü / Size
220 2063 000 032+	



Plastik El Sepeti Stok Arabası
Plastic Hand Basket Carrier

Kod / Code	Ölçü / Size
220 3050 033 045 001	



El Sepeti Arabası
Shopping Basket Carrier

Kod / Code	Ölçü / Size
220 1171	



Kullanım Alanı
Area Of Use
90x59

Yük Arabası Tip-1 / Transport Trolley Type-1

220 2010 102 060 090 Ölçü / Size : 102x90x60



Kullanım Alanı
Area Of Use
94x59

Yük Arabası Tip-2 / Transport Trolley Type-2

220 2020 095 124 072 Ölçü / Size : 98x124x72



Kullanım Alanı
Area Of Use
81x54

Yük Arabası Tip-3 / Transport Trolley Type-3

220 2031 095 085 055 Ölçü / Size : 93x91x54



Kullanım Alanı
Area Of Use
77x54

Yük Arabası Tip-4A / Transport Trolley Type-4A

220 2032 095 085 055 Ölçü / Size : 93x99x54



Kullanım Alanı
Area Of Use
77x47

Yük Arabası Tip-4B / Transport Trolley Type-4B

220 2032 095 085 055 001 Ölçü / Size : 93x99x54



Kullanım Alanı
Area Of Use
66x45

Yük Arabası Tip-5A / Transport Trolley Type-5A

220 2050 080 045 070 Ölçü / Size : 82x99x54



Kullanım Alanı
Area Of Use
125x76

Yük Arabası Tip-8 / Transport Trolley Type-8

220 2040 105 075 125 Ölçü / Size : 105x143x76

Yük Arabası Tip-6A / Transport Trolley Type-6A

220 2150 116 060 045 Ölçü / Size : 116x60x45



Yük Arabası Tip-6B / Transport Trolley Type-6B

220 2050 117 065 090 Ölçü / Size : 111x65x90



Kullanım Alanı
Area Of Use
91x60

Yük Arabası Tip-5B / Transport Trolley Type-5B

220 2050 096 095 060 Ölçü / Size : 82x77x43



125'lik Kırmızı Teker
125 Ø Red Wheel

Bilyalı Rulan Teker / Rooller Bearing Wheel
Kapasite / Capacity : 125 kg
Çap / Diameter : 125 mm
220 9231 000



125'lik Frenli Kırmızı Teker
125 Ø Red Wheel With Brake

Bilyalı Rulan Teker / Rooller Bearing Wheel
Kapasite / Capacity : 125 kg
Çap / Diameter : 125 mm
220 9231 001

Tablalı Teker Özellikleri / Wheel With Metal Plate Specification



125'lik Sabit Başlıklı Rolot Teker
125 Ø Roll Container Fixed Wheel

Tabla Ölçüsü / Tray Sizes : 105x85 mm
Kapasite / Capacity : 140 kg
Çap / Diameter : 125 mm
220 9023 001 125



125'lik Döner Başlıklı Rolot Teker
125 Ø Roll Container Revolving Headed Wheel

Tabla Ölçüsü / Tray Sizes : 105x85 mm
Kapasite / Capacity : 140 kg
Çap / Diameter : 125 mm
220 9023 001 125



Rulot (2 Taraflı) Tip-1
Roll Container (2 Sided) Type-1

Kod / Code	Ölçü / Size
220 5020	1700x800x700 - 1900x900x700



Rulot (Z Profil Şase)
Roll Container (Z Profile Body)

Kod / Code	Ölçü / Size
220 5030 170 000 080	1700x700x800



Rulot Kayışı
Belt For Roll Container

Kod / Code	Ölçü / Size
220 5161	



Rulot Tel Raf
Wire Shelf For Roll Container

Kod / Code	Ölçü / Size
220 5151	



Rulot (4 Taraflı) Tip-2
Roll Container (4 Sided) Type-2

Kod / Code	Ölçü / Size
220 5030	1700x700x800 - 1900x700x900



Rulot Katlanabilir
Folding Roll Container

Kod / Code	Ölçü / Size
220 5050 170 070 080	1700x700x800





Derinlik Ayarlı Sepet
Depth Adjustable Basket

Kod / Code	Ölçü / Size
210 1000 086 035 060	860x350x600
210 1000 086 060 060	860x600x600
210 1000 086 060 080	860x600x800
210 1000 086 060 120	860x600x1200
210 1000 086 080 080	860x800x800
210 1000 086 080 120	860x800x1200



Derinlik Ayarlı Havuz Sepet Panosu
Depth Adjustable Basket Panel

Kod / Code	Ölçü / Size
210 1070 085 000 080	860x800
210 1070 085 000 120	860x1200

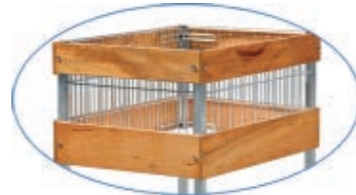
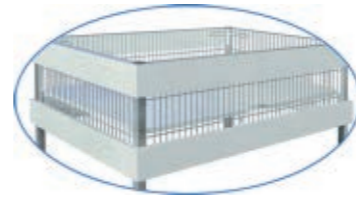

Yan Kapama Takımı
Side Closure

Kod / Code	Ölçü / Size
210 1034 000 060 080	600x8600
210 1034 000 080 120	800x1200



Tekstil Aparatı
Textile Display Stand

Kod / Code	Ölçü / Size
219 1071 000 098 055	585x980

Üst Kat Aparatı 26
Promotion Basket Level Apparatus 26

Kod / Code	Ölçü / Size
219 1071 000 026 077	300x260x770

Üst Kat Aparatı 32
Promotion Basket Level Apparatus 32

Kod / Code	Ölçü / Size
219 1071 000 032 077	420x320x770

Promosyon Sepeti
Promotion Basket

Kod / Code	Ölçü / Size
210 1000 060 080 073	730x600x800

Palet ürüne dahil değildir
Pallets are not included to the product

Çift Yönlü Derinlik Ayarlı Havuz Sepet
Double Sided Depth Adjustable Promotion Basket

Kod / Code	Ölçü / Size
210 1100 150 050 120	1500x1000x1200





Kasa Yan Stand
Checkout Promotion Unit (Side)

Kod / Code	Ölçü / Size
110 4000 060 140+	1400x250x600



Derinlik Ayarlı Sepet (40x50)
Depth Adjustable Basket (40x50)

Kod / Code	Ölçü / Size
229 1000 086 040 050	860x400x500

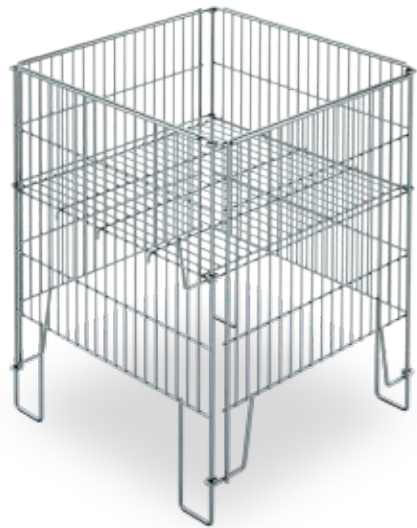

Promosyon Sepet
Promotion Basket

Kod / Code	Ölçü / Size
210 3010 090 055 055	700x550x550



Üst Kat Aparatı 26
Promotion Basket Level Apparatus 26

Kod / Code	Ölçü / Size
219 1071 000 026 080	860x260x800
219 1071 000 026 120	860x260x1200

Üst Kat Aparatı 32
Promotion Basket Level Apparatus 32

Kod / Code	Ölçü / Size
219 1071 000 032 080	420x320x800
219 1071 000 032 120	420x320x1200

Çift Katlı Havuz Sepet
Double Levelled Promotion Basket

Kod / Code	Ölçü / Size
229 1000 086 060 080	860x600x800
229 1000 086 080 120	860x800x1200

4 Katlı Aksiyon Sepet
Four Levels Rack On Wheels

Kod / Code	Ölçü / Size
220 2060 165 050 070	1650x500x700
220 2060 165 050 100	1650x500x1000





Konteyner
Container

Kod / Code	Ölçü / Size
220 4010 085+	85x60x80 - 85x80x120

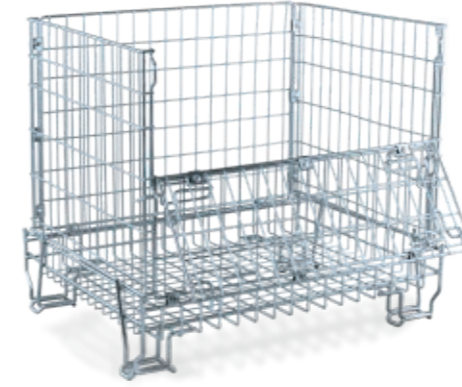

Ayaklı Konteyner
Container With Leg

Kod / Code	Ölçü / Size
220 4010 085 085 110	850x850x1100



Konteyner Arabası
Container Carrier

Kod / Code	Ölçü / Size
220 4032 015+	150x600x80 -150x800x1200



Profil Konteyner
Container Box Profile

Kod / Code	Ölçü / Size
220 4021 128 090 130	1280x900x130



Somçelik

RAF SİSTEMLERİ

KAYSERİ (FABRİKA / FACTORY)
Organize Sanayi Bölgesi 24.Cad
No:55 KAYSERİ / TÜRKİYE
Tel : +90 352 321 13 00
Faks : +90 352 321 16 38
E-Mail :somcelik@somcelik.com
foreigntrade@somcelik.com



KAYSERİ (FABRİKA / FACTORY)
Organize Sanayi Bölgesi 35.Cad
No:26 KAYSERİ / TÜRKİYE
Tel : +90 352 321 13 00
E-Mail : somcelik@somcelik.com



KAYSERİ (ŞUBE / BRANCH)
Sanayi Bölgesi 4.Cad. No:1/A
KAYSERİ / TÜRKİYE
Tel : +90 352 336 07 89
Faks : +90 352 336 40 82
E-Mail : kayseri@somcelik.com



İÇ ANADOLU BÖLGE MÜDÜRLÜĞÜ
CENTRAL ANATOLIA REGIONAL OFFICE
Kazım Karabekir Cad. Efeler İş Merk
No:89/23 İskitler ANKARA/TÜRKİYE
KAYSERİ/TÜRKİYE
Tel : +90 312 384 21 16
Faks : +90 312 384 21 17
E-Mail : ankara@somcelik.com



www.somcelik.com



Bayi / Our Dealer

TURKEY

Discover
the potential